

Application note for RFS Twistflex

Installation & Handling Instruction for RFS Twistflex



This guideline is written for qualified and experienced personnel. Please study carefully before starting any work. Any liability or responsibility for the result of improper or unsafe installation is disclaimed.

Handling and Storage

Twistflex's are manufactured for optimum performance. It is important that their dimension and shape is maintained and that no humidity or dirt can enter.

Therefore all Twistflex's should be stored and transported in their original packing until use.

RFS Twistflexes are packed in a sealed polythene foil (Figure 1) in order to protect the internal waveguide surfaces from oxidation. This packing seals against humidity and dirt. The protection caps fitted onto the Twistflex prevent damage to the flange faces and keep dirt out. These caps (Figure 2) should be kept in place until mating with other flanges. Handle the complete package with care. Do not stock or transport stacked and never stock other materials on the Twistflex package. The gasket for the P-flange is part of the delivery and is included in the package.



Figure 1



Figure 2



Temperature Specifications:

Operating temperature:

In general, the temperature range should be kept between -25°C and +85°C (-13°F to 185°F)

The temperature can be decreased to -45°C (-49°F) with some reduction in flexibility.

Storage temperature:

-55°C to +85°C (-67°F to +185°F)

Installation temperature:

-40°C to +60°C (-40°F to 140°F) - with some reduction in flexibility at -40°C (-40°F).

Specifications subject to change without notice

Installation

Sufficient space is needed for the installation.

The flanges and the fixations must be aligned correctly before matching.

Twistflex should not be stretched or forced to mate with bracket, flange or clamp.

Particular attention has to be taken to the minimum bending radius in both planes (E-plane & H-plane, see figure 3, 4 & 6) and to the max. twisting rate (see figure 4).

The Twistflex should not be bended close to the flange. A straight section with a minimum length **A** should always be kept (shown in Figure 4 & 5). Do not stretch the Twistflex.

It is strongly recommended to fix the Twistflex (see Topic Vibration below).

In certain climates consideration should also be given to potential ice load and appropriate support provided.

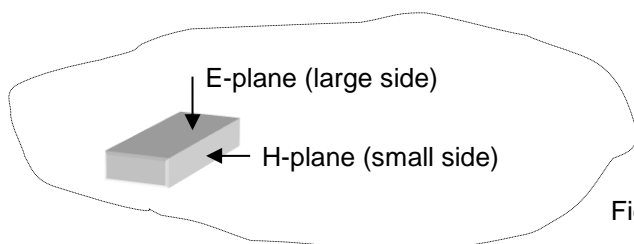

Figure 3

Figure 4

Mechanische Angaben / Mechanical Specifications					
RFS Model Nr. Model No.	Hohlleitergröße Waveguide Size IEC (EIA)	Min. Biegeradius BR Bending Radius BR		Min. Länge A Min. length A mm (in)	Drehbarkeit Twisting Rate Grad/m (deg/ft)
		E-plane mm (in)	H-plane mm (in)		
TF040-DV* ^{***} M	R40 (WR229)	165 (6.5)	330 (13.0)	80 (3.2)	64 (19)
TF048-DV* ^{***} M	R48 (WR187)	165 (6.5)	330 (13.0)	65 (2.6)	82 (25)
TF070-DV* ^{***} M	R70 (WR137)	100 (4.0)	205 (8.1)	50 (2.0)	115 (35)
TF084-DV* ^{***} M TF084-BW* ^{***} M	R84 (W112)	75 (3.0)	150 (5.9)	40 (1.6)	140 (42)
TF100-DV* ^{***} M TF100-BW* ^{***} M	R100 (WR90)	66 (2.6)	130 (5.1)	40 (1.6)	156 (47)
TF120-DV* ^{***} M TF120-BW* ^{***} M	R120 (WR75)	65 (2.6)	115 (4.5)	40 (1.6)	180 (55)
TF140-DV* ^{***} M TF140-BW* ^{***} M	R140 (WR62)	65 (2.6)	100 (4.0)	40 (1.6)	200 (61)
TF220-BW* ^{***} M	R220 (WR42)	38 (1.5)	75 (3.0)	20 (0.8)	270 (82)
TF260-BW* ^{***} M	R260 (WR34)	25 (1.0)	75 (3.0)	20 (0.8)	270 (82)
TF320-BW* ^{***} M	R320 (WR28)	25 (1.0)	50 (2.0)	20 (0.8)	360 (110)

^{***} Length of Twistflex in cm = 30, 60, 90, 120
(all lengths are subject to a tolerance of +/-3%)

Specifications subject to change without notice

Figure 5

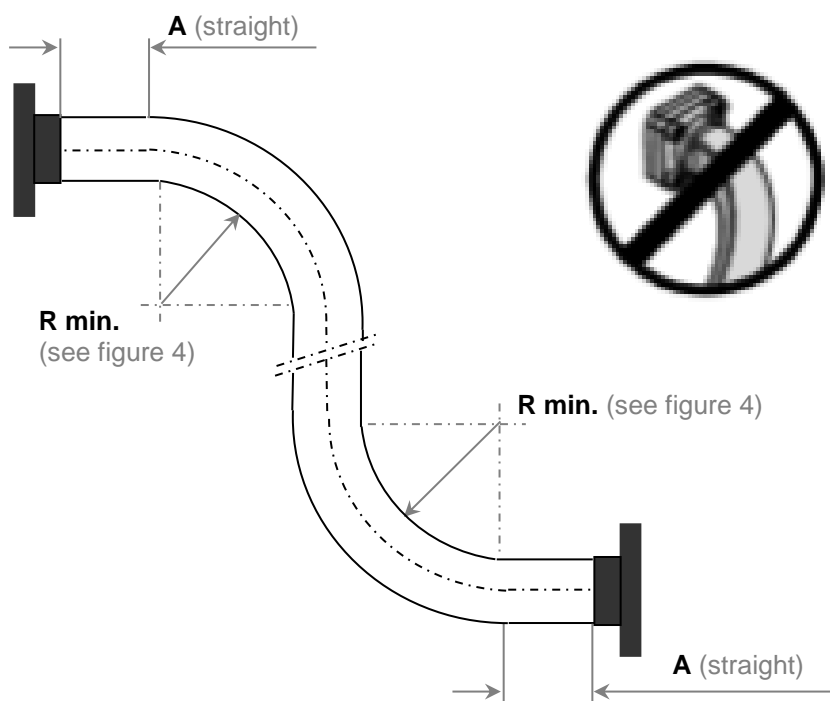

Vibration

Vibration on the Twistflex should be kept to a minimum. If the unit is in a stressed (tensile) condition (e.g. Twistflex can move due to wind) as the rubber jacket may become more susceptible to “ozone” and general environmental attack, this means the Twistflex can be damaged more easily.

In order to prevent any movements it is strongly recommended to fix the Twistflex e.g. with clamps (Hardware/Fixing accessories available). If fixing the Twistflex attention must be taken not to crush the Twistflex core.

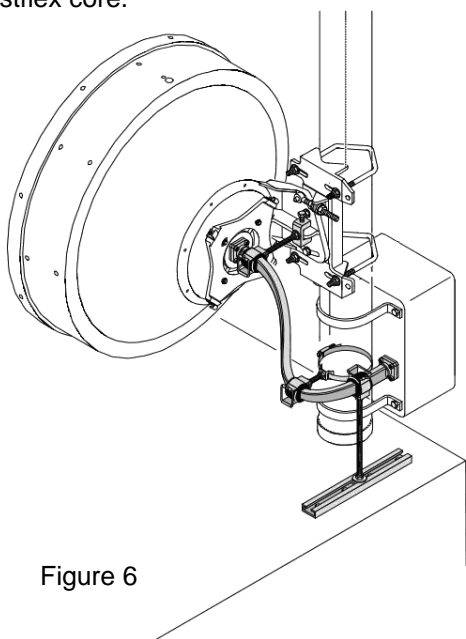

Figure 6

The Twistflex has to be fixed in order to avoid any damaging by movement or vibration!
To minimise any stress on the flanges it is strongly recommended to fix the Twistflex close to the ends (see Figure 6) in the straight sections **A** on Antenna, Radio etc.

Specifications subject to change without notice

Fixation

In order to avoid damaging of the Twistflex the clamps for fixation are provided with clamp linings (see Figure 7 – available clamps see Figure 8). The clamp linings allow fixing the Twistflex in any position. Do not over tighten the clamps!

Figure 7



Figure 8

Model Number	For Twistflex	Rectangular Waveguide	EIA norm
CLAMP-TF048	TF048- xxx - xxx M	R48	WR-187
CLAMP-TF070	TF070- xxx - xxx M	R70	WR-137
CLAMP-TF084	TF084- xxx - xxx M	R84	WR-112
CLAMP-TF100	TF100- xxx - xxx M	R100	WR-90
CLAMP-TF120	TF120- xxx - xxx M	R120	WR-75
CLAMP-TF140	TF140- xxx - xxx M	R140	WR-62
CLAMP-TF220	TF220- xxx - xxx M	R220	WR-42
CLAMP-TF260	TF260- xxx - xxx M	R260	WR-34
CLAMP-TF320	TF320- xxx - xxx M	R320	WR-28

└── Length of Twistflex
 (E.g. 030M [0,3m], 060M [0,6m], 090M [0,9m], 120M [1,2m])
└── Material of flange
 (e.g. 1 = silver plated, 2 = brass, 3 = tin plated)
└── Flange Types
 (e.g. DV = PDR-flange & UDR-flange)

Specifications subject to change without notice

The fixation onto interfaces directly to e.g. Steel construction of a Mast etc. can be made with standard Fixation accessories (see Figures 9).

Basic Hanger Assembly (see Figure 10) can be used in case the distance between Twistflex and existing construction is too large for direct fixation.

Figure 9

Fixation of CLAMP-TF048 & CLAMP-TF070

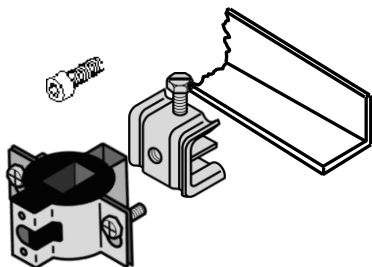

with Cleat **MKD-10** (screw not included)
or Cleat **ANGLE-SM8-10** (screw included)
to Flat-, Angle-, U-irons etc.

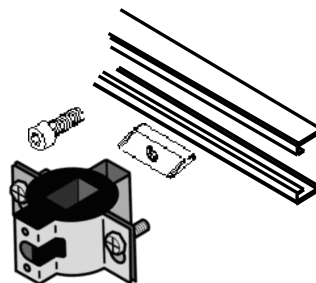

with Hardware **HUA-M8**
to anchor bar

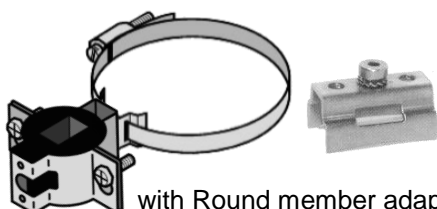

with Round member adapter **TRB-8**
to Round member
Available round member see below (Figures 12)



Clamps can also fixed e.g. to wall (with dowel & screw)

Fixation of CLAMP-TF084 up to CLAMP-TF320

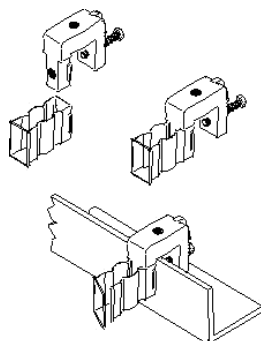

with Cleat **RSB-310**
to Flat-, Angle-, U-irons etc.

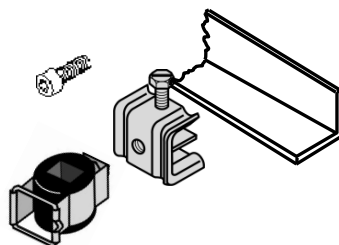

or with Cleat **MKD-10** (screw not included)
or Cleat **ANGLE-SM8-10** (screw included)
to Flat-, Angle-, U-irons etc.

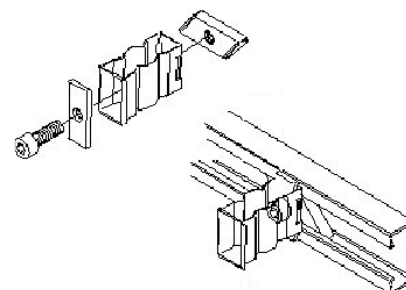

with **RSB-315**
to Anchor bar

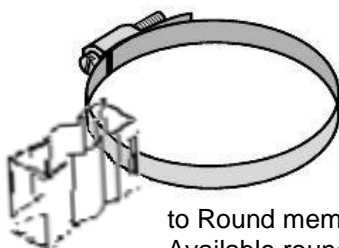

to Round member
Available round member
see below (Figures 11)

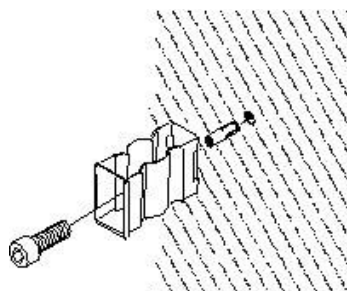

Clamps can also
fixed e.g. to wall
(with dowel & screw)

Specifications subject to change without notice

Figure 10

Fixation of CLAMP-TF048 up to CLAMP-TF320 with Basic Hanger Assembly

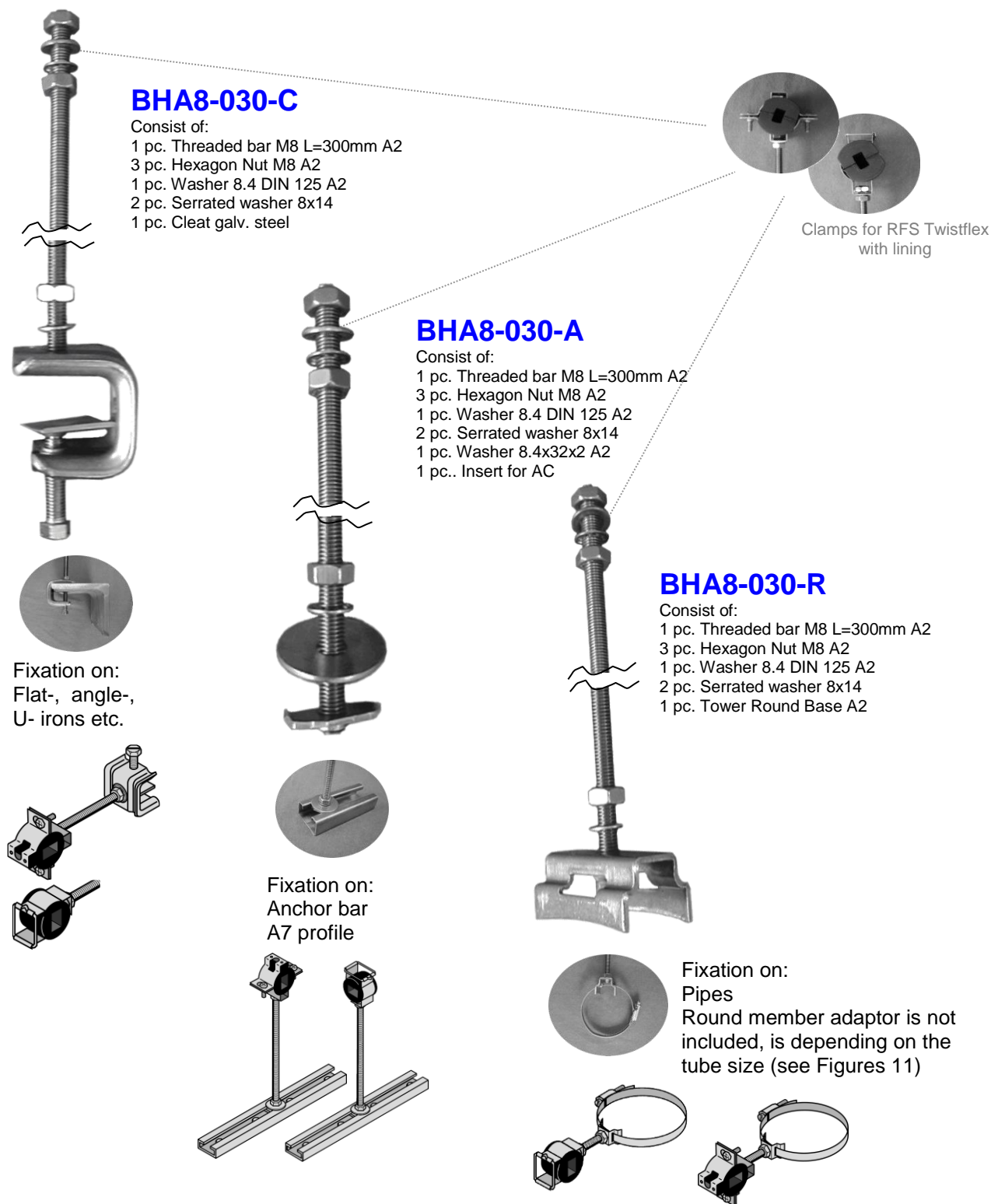

Specifications subject to change without notice

Figure 11

Round member adapters (e.g. for the fixation of BHA8-030-R)



STRAP-2

Consist of:

- 30m of strap
- 50 pieces of fasteners

Also available as separate parts:
 30m of strap = Art. No.: 15802840
 1 Kit of 50 piece of fastener = Art. No.: 15802841



Max. Pressure

The max. pressure is limited to the antenna systems of 4,35 PSIG/0.3bar typically.

Humidity

If the Twistflex is installed according to standard rules (connection of P-& U-Flanges or two P-Flanges with a Shim in-between -see Figure 12) humidity will not have any affect. If an air inlet is available (on the Connector of FLEXWELL® Waveguide or DC-Kit) Twistflex can be purged regularly with dry air by dehydrator, or observed by a desiccant cartridge.

Figure 12

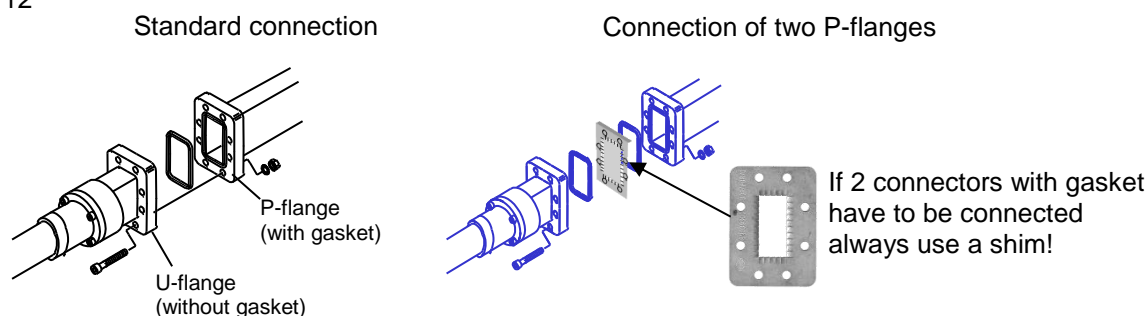

Plating

Note the standard rules of potential difference for inter metallic conductions. The difference shall not exceed 0.3V to avoid corrosion. Silver plated flanges can be connected to silver or brass flanges. Silver plated flanges shall not connect to aluminium, because the potential difference is 0.75V and intensive corrosion can occur.

Specifications subject to change without notice