

SC1/SCX1 ANTENNA

INSTALLATION INSTRUCTIONS



1 / 2







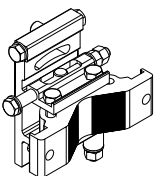
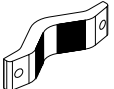
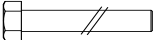

NMT-10-1134-01

SC1/SCX1 ANTENNA

INSTALLATION INSTRUCTIONS



2 / 2

-  Mount x1
-  Clamp x1
-  M10x140 x2
-  M10x30 x3
-  M8x10 x1
-  Washer A10,5 x5
-  Washer W10 x3
-  Nut M10 x4
-  Nut M10 x2
-  Rain cap x1
-  Grease x1

Reflector + feed x1

Customer Interface

NMT-20-.....

Offset left

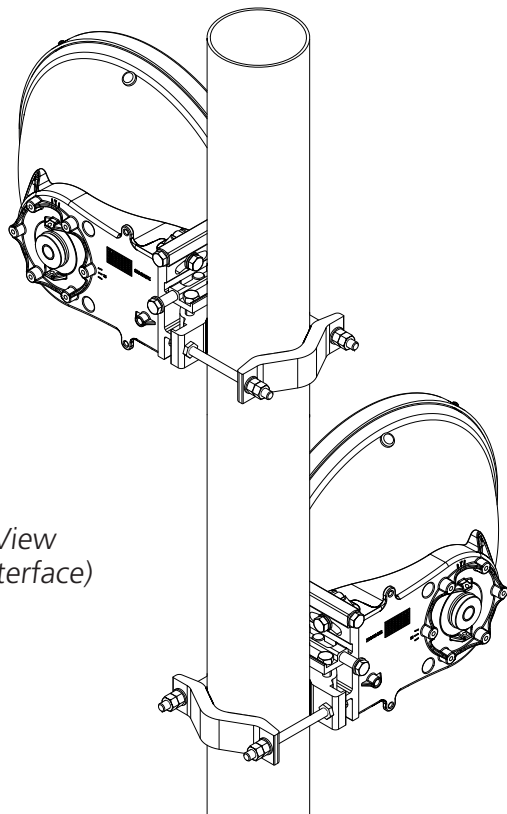

Generic View
(Standard Interface)

Offset right

Required tools

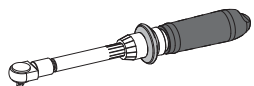

3...45N.m



10/17



4



10/17

It is important to mount the antenna exactly as described in this installation instruction.
The installed antenna shall be inspected once per year by qualified personnel.
RFS disclaims any responsibility for the result of improper or unsafe installation.
This installation instruction has been written for qualified, skilled personnel.

We reserve the right to alter details, especially with respect to technical improvement