



Rectangular Waveguide R 48 E-Bend 90 degree,  
flanges PDR/UDR 48, f= 3.94-5.99 GHz,  
VSWR max 1.06, A=150mm (5.9"),  
gasket and screw kit enclosure  
made of brass

**FEATURES / BENEFITS**

Waveguide installation

- The rectangular waveguide component provides simple installation in particular difficult cases
- It can be installed where less space is available
- It provides outstanding electrical performance

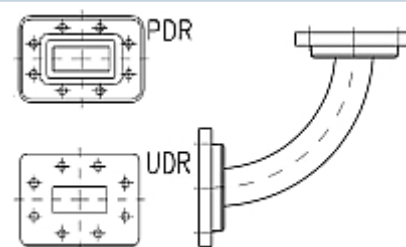

Picture only for illustration

**Technical features**

**STRUCTURE**

Type of Rectangular Waveguide Component		Bend in E-Plane
Waveguide Size IEC (EIA)		R48 (WR187)
Flange A		PDR48
Flange B		UDR48
Flange Finish		Brass un-plated
Package Quantity		1

**ELECTRICAL SPECIFICATIONS**

Minimum Return Loss (max. VSWR)	dB (VSWR)	30.7 (1.06)
---------------------------------	-----------	-------------

**MECHANICAL SPECIFICATIONS**

Bend/Twist	degree	90
Length	mm (in)	150 (5.9)

**MATERIAL**

Material		Brass
Color		Black

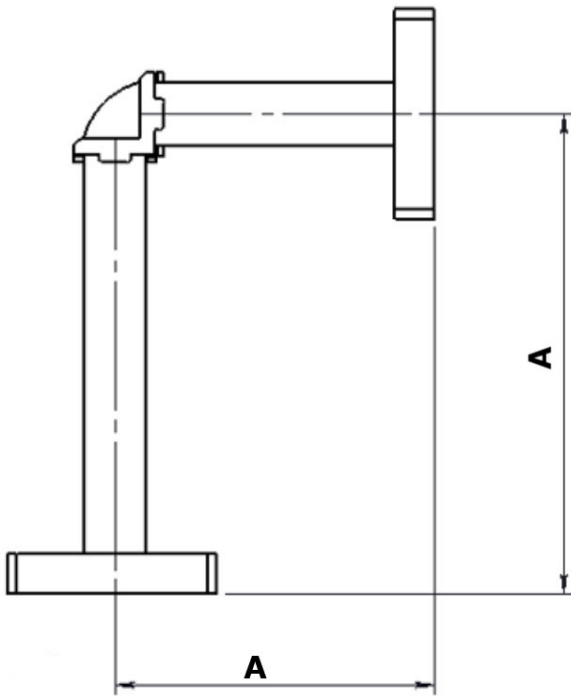

Design with casted bend

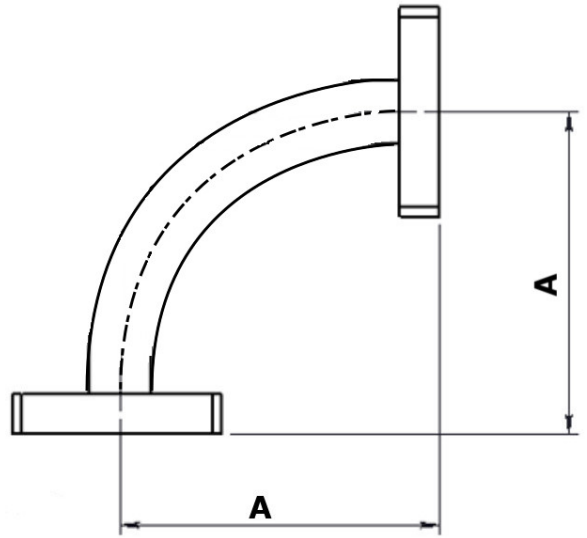

Design with accurate waveguide bend

External Document Links

Notes