



Rectangular Waveguide R 70 H-Bend 90 degree,
flanges PDR/UDR 70, f= 5.38-8.17 GHz,
VSWR max 1.06, A=125mm (4.9in),
gasket and screw kit enclosure
made of brass

FEATURES / BENEFITS

Waveguide installation

- The rectangular waveguide component provides simple installation in particular difficult cases
- It can be installed where less space is available
- It provides outstanding electrical performance

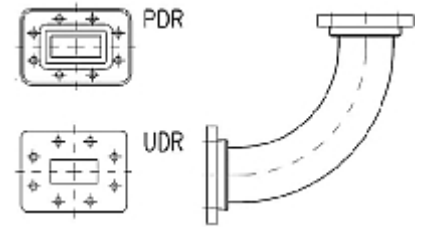

Picture only for illustration

Technical features

STRUCTURE

Type of Rectangular Waveguide Component		Bend in H-Plane
Waveguide Size IEC (EIA)		R70 (WR137)
Flange A		PDR70
Flange B		UDR70
Flange Finish		Brass un-plated
Package Quantity		1

ELECTRICAL SPECIFICATIONS

Minimum Return Loss (max. VSWR)	dB (VSWR)	30.7 (1.06)
---------------------------------	-----------	-------------

MECHANICAL SPECIFICATIONS

Bend/Twist	degree	90
Length	mm (in)	125 (4.9)

MATERIAL

Material		Brass
Color		Black

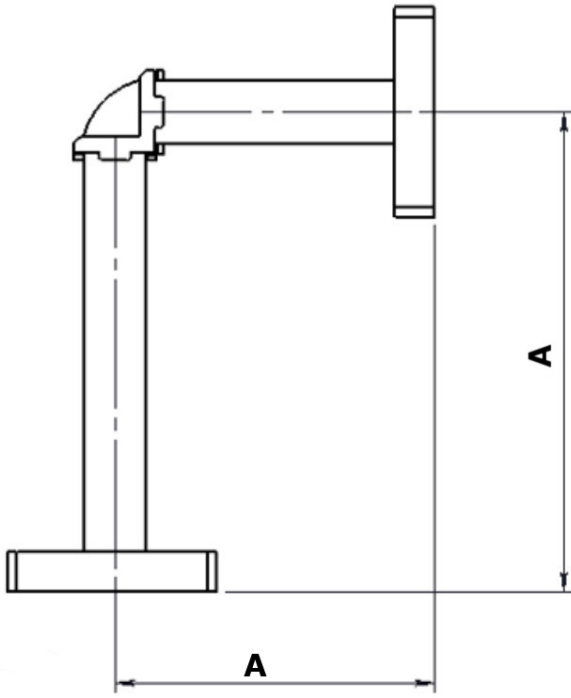

Design with casted bend

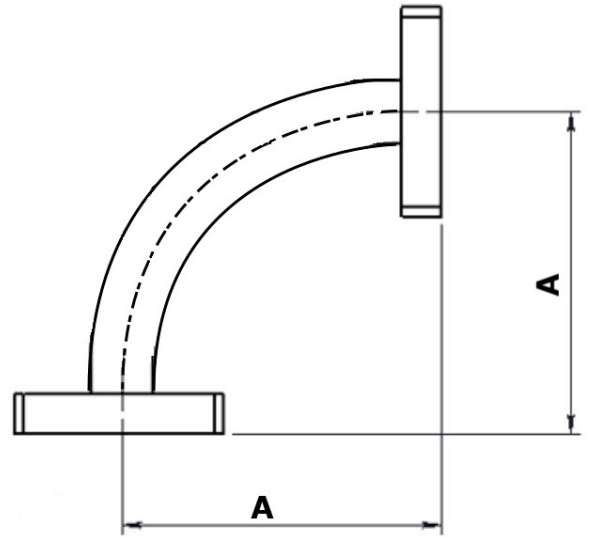

Design with arcuate waveguide bend

External Document Links

Notes