



Rectangular Waveguide R 220 H-Bend 90 degree,
flanges PBR/UBR 220, f= 17.6-26.70 GHz,
VSWR max 1.10, A=50mm (1.9in),
gasket and screw kit enclosure
made of copper

FEATURES / BENEFITS

Waveguide installation

- The rectangular waveguide component provides simple installation in particular difficult cases
- It can be installed where less space is available
- It provides outstanding electrical performance

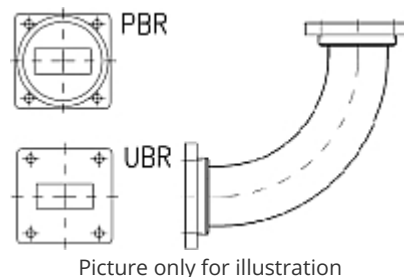

Technical features

STRUCTURE

Type of Rectangular Waveguide Component		Bend in H-Plane
Waveguide Size IEC (EIA)		R220 (WR42)
Flange A		PBR220
Flange B		UBR220
Flange Finish		Brass un-plated
Package Quantity		1

ELECTRICAL SPECIFICATIONS

Minimum Return Loss (max. VSWR)	dB (VSWR)	26.4 (1.10)
---------------------------------	-----------	-------------

MECHANICAL SPECIFICATIONS

Bend/Twist	degree	90
Length	mm (in)	50 (1.9)

MATERIAL

Material		Copper
Color		Black

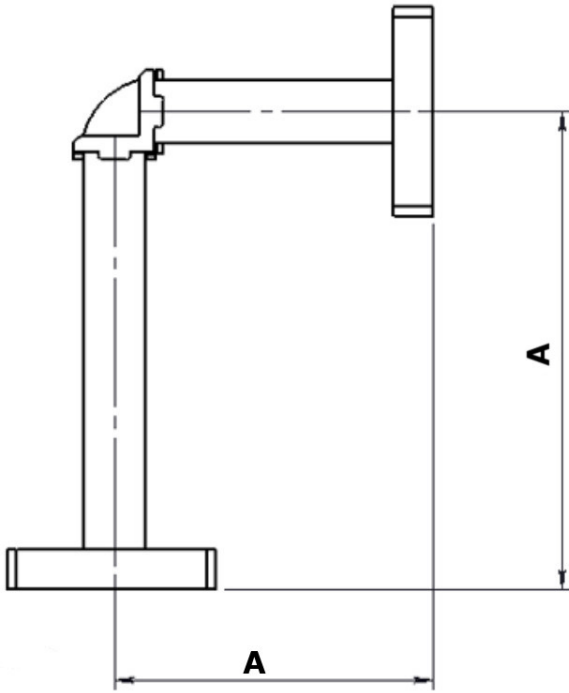

Design with casted bend

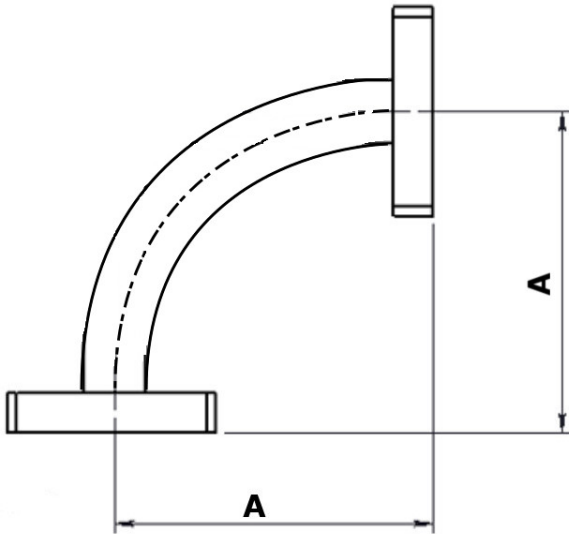

Design with arcuate waveguide bend

[External Document Links](#)

[Notes](#)