



Hangers for the installation of HELIFLEX® cables on different supporting profiles.
 Cable Clamp and Extended Counterbed hot-galvanized steel
 Screw: stainless steel.

FEATURES / BENEFITS



picture shows the 1L4 version for illustration purpose only

Technical features

GENERAL SPECIFICATIONS

Product Line		Coaxial Cable Accessories
Product Type		Hanger
Hanger Type		Angle iron 40mm (1.575")
Transmission Line Type		HCA118
Cable Type		Air Dielectric Coaxial Foam Dielectric

MECHANICAL SPECIFICATIONS

Cable Size		1-1/8
Material		Cable Clamp : hot-dip galvanized Extended Counterbed : hot-dip galvanized Screw: Stainless steel
Recommended / Maximum Clamp Spacing	m (ft)	0.5 / 0.9 (1.8 / 3)

TEMPERATURE SPECIFICATIONS

Operation Temperature	°C (°F)	-50 to 85 (-58 to 185)
Storage Temperature	°C (°F)	-50 to 85 (-58 to 185)

PACKAGING INFORMATION

Package Quantity		1
Weight per piece	kg (lb)	0.135 (0.3)



HCH-118-1L4

Cable hanger for HELIFLEX® Air-dielectric coaxial cable

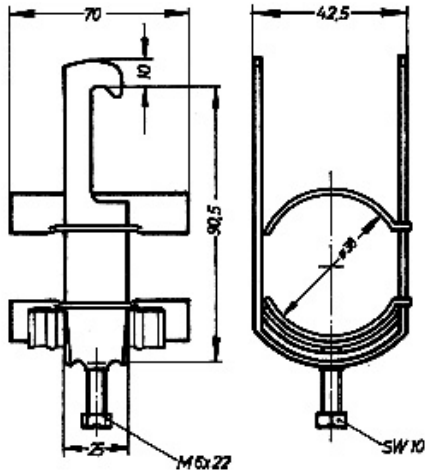

External Document Links

Notes

Hangers for angle iron 40mm (1.575")