



Hangers for the installation of HELIFLEX® cables on different supporting profiles.

Cable Clamp and Extended Counterbed hot-galvanized steel

Screw: stainless steel.

FEATURES / BENEFITS



picture shows the 1L4 version for illustration purpose only

Technical features

GENERAL SPECIFICATIONS

Product Line		Coaxial Cable Accessories
Product Type		Hanger
Hanger Type		Anchor bar 18-22mm (0.71-0.87")
Transmission Line Type		HCA158
Cable Type		Air Dielectric Coaxial Foam Dielectric

MECHANICAL SPECIFICATIONS

Cable Size		1-5/8
Material		Cable Clamp : hot-dip galvanized Extended Counterbed : hot-dip galvanized Screw: Stainless steel
Recommended / Maximum Clamp Spacing	m (ft)	0.8 / 1.2 (2.75 / 4)

TEMPERATURE SPECIFICATIONS

Operation Temperature	°C (°F)	-50 to 85 (-58 to 185)
Storage Temperature	°C (°F)	-50 to 85 (-58 to 185)

PACKAGING INFORMATION

Package Quantity		1
Weight per piece	kg (lb)	0.18 (0.4)



HCH-158-1C

Cable hanger for HELIFLEX® Air-dielectric coaxial cable

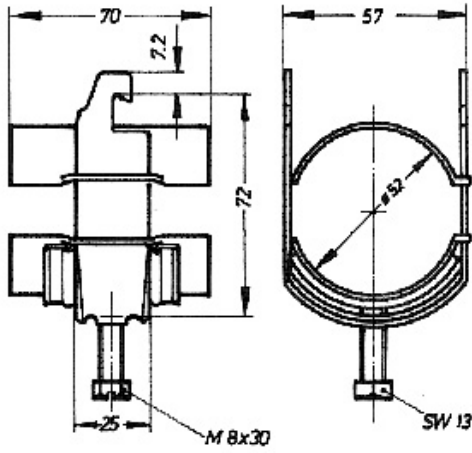

External Document Links

Notes

Hangers for anchor bar 18-22 mm (0.71-0.87")