



Rectangular Waveguide R 120 E-Bend 90 degree,
flanges PBR/UBR 120, f= 9.84-15.0 GHz,
VSWR max 1.06, A=65mm (2.5"),
gasket and screw kit enclosure
made of brass

FEATURES / BENEFITS

Waveguide installation

- The rectangular waveguide component provides simple installation in particular difficult cases
- It can be installed where less space is available
- It provides outstanding electrical performance

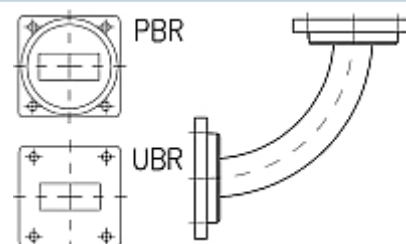

Picture only for illustration

Technical features

STRUCTURE

Type of Rectangular Waveguide Component		Bend in E-Plane
Waveguide Size IEC (EIA)		R120 (WR75)
Flange A		PBR120
Flange B		UBR120
Flange Finish		Brass un-plated
Package Quantity		1

ELECTRICAL SPECIFICATIONS

Minimum Return Loss (max. VSWR)	dB (VSWR)	30.7 (1.06)
---------------------------------	-----------	-------------

MECHANICAL SPECIFICATIONS

Bend/Twist		90 deg
Length	mm (in)	65 (2.5)

MATERIAL

Material		Brass
Color		Black

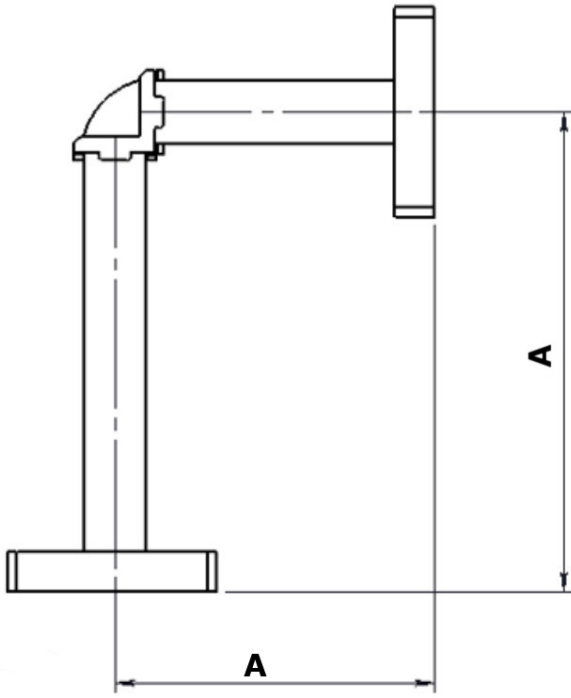

Design with casted bend

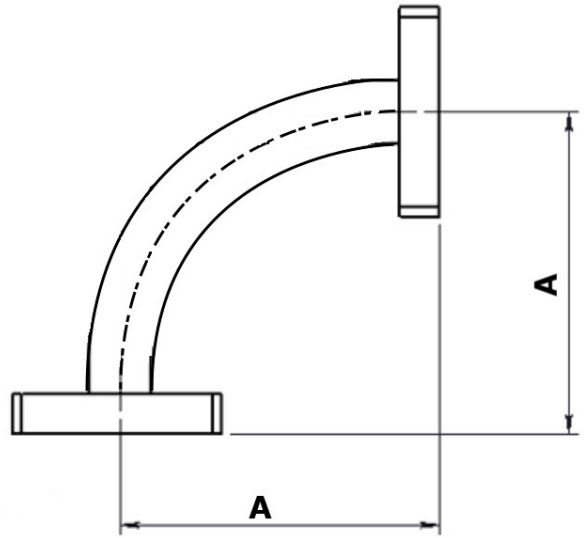

Design with accurate waveguide bend

External Document Links

Notes