



Hangers for the installation of HELIFLEX® cables on different supporting profiles.
 Cable Clamp and Extended Counterbed hot-galvanized steel
 Screw: stainless steel.

FEATURES / BENEFITS



picture shows the 1L4 version for illustration purpose only

Technical features

GENERAL SPECIFICATIONS

Product Line		Coaxial Cable Accessories
Product Type		Hanger
Hanger Type		Flat iron 6-12mm (0.24-0.47")
Transmission Line Type		HCA118
Cable Type		Air Dielectric Coaxial Foam Dielectric

MECHANICAL SPECIFICATIONS

Cable Size		1-1/8
Material		Cable Clamp : hot-dip galvanized Extended Counterbed : hot-dip galvanized Screw: Stainless steel
Recommended / Maximum Clamp Spacing	m (ft)	0.5 / 0.9 (1.8 / 3)

TEMPERATURE SPECIFICATIONS

Operation Temperature	°C (°F)	-50 to 85 (-58 to 185)
Storage Temperature	°C (°F)	-50 to 85 (-58 to 185)

PACKAGING INFORMATION

Package Quantity		1
Weight per piece	kg (lb)	0.13 (0.29)



HCH-118-1R

Cable hanger for HELIFLEX® Air-dielectric coaxial cable

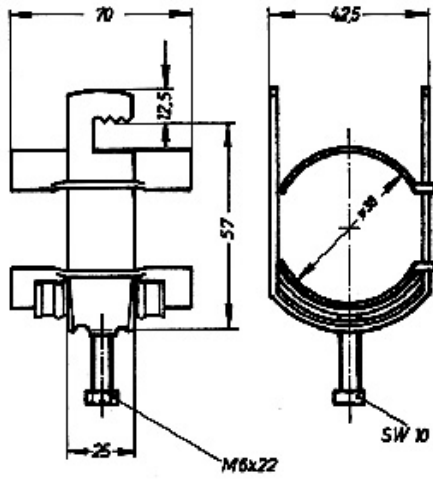

External Document Links

Notes

Hangers for flat iron 6-12 mm (0.24-0.47")