



RFS CompactLine® and CompactLine® Easy Antennas are designed for short-haul microwave systems in all common frequency ranges from 6 GHz to 86 GHz. They are typically deployed in dense urban areas, metropolitan and suburban locations, aggregation points. They are especially optimized to integrated radios to reduce costs, installation complexity and time.

**FEATURES / BENEFITS**

- Sizes ranging from 0.3 m (1 ft) to 1.8 m (6 ft)
- Frequencies ranging from 5.925 GHz to 86 GHz with support for four wideband frequency ranges (5.925-7.125, 7.125-8.5, 10.0-11.7, and 71.0-86.0 GHz) to reduce antenna requirements and simplify logistics
- Single (SB and SC) and dual-polarized (SBX and SCX) models with the ability to upgrade from single to dual polarization and change frequencies in the field
- Low-profile design to reduce transportation requirements, wind load and antenna weight
- Simplified mounting design to accelerate installation
- CompactLine EASY models are extra light and easy to transport, deploy and upgrade
- Hardcover radomes
- Tested and validated ultra-high (ETSI EN 302 217-4-2 Class 3, FCC Class A) electrical performance
- Support for winds up to 250 km/h (155 mph) and even 320 km/h (195 mph) for SB1/SBX1
- An optional sway bar for antennas 1 m (3 ft) and larger is available



**Technical features**

**GENERAL SPECIFICATIONS**

<b>Product Type</b>		Point to point antennas
<b>Profile</b>		CompactLine
<b>Performance</b>		Ultra High
<b>Polarization</b>		Dual
<b>Antenna Input</b>		PBR 120
<b>Reflector</b>		1-part
<b>Radome</b>		rigid
<b>Antenna color</b>		White RAL 9010
<b>Swaybar</b>		1: (1.9 m x Ø60 mm)

**ELECTRICAL SPECIFICATIONS**

<b>Frequency</b>	GHz	12.7 - 13.25
<b>3dB beamwidth</b>	degrees	0.9
<b>Low Band Gain</b>	dBi	45.1
<b>Mid Band Gain</b>	dBi	45.4
<b>High Band Gain</b>	dBi	45.7
<b>F/B Ratio</b>	dB	72
<b>XPD</b>	dB	30
<b>IPI</b>	dB	35
<b>Max VSWR / R L</b>	VSWR / dB	1.3 (17.7)
<b>Regulatory Compliance</b>		ETSI EN 302217 Range 1 Class 3 FCC Category A



**MECHANICAL SPECIFICATIONS**

Diameter	ft (m)	6 (1.8)
Elevation Adjustment	degrees	± 5
Azimuth Adjustment	degrees	± 5
Polarization Adjustment	degrees	± 5
Mounting Pipe Diameter minimum	mm (in)	114 (4.5)
Mounting Pipe Diameter maximum	mm (in)	114 (4.5)
Approximate Weight	kg (lb)	90 (198)
Survival Windspeed	km/h (mph)	252 (155)
Operational Windspeed	km/h (mph)	252 (155)

**STRUCTURE**

Radome Material		rigid
-----------------	--	-------

**FURTHER ACCESSORIES**

optional Swaybar		1: SMA-SK-6 (1.9 m x Ø60 mm)
Further Accessories		SMA-SKO-UNIVERSAL-L : Universal sway bar fixation kit

**MOUNTOUTLINE**

Dimension_A	mm (in)	1900 (74.8)
Dimension_B	mm (in)	910 (35.8)
Dimension_C	mm (in)	362 (14.3)
Dim_D- 114mm(4.5_in)Pipe	mm (in)	416 (16.4)
Dimension_E	mm (in)	83 (3.3)
Dimension_F	mm (in)	785 (30.9)
Dimension_G	mm (in)	305 (12)





**WINDLOAD**

<b>F<sub>s</sub> Side force max. @ survival wind speed</b>	N (lb)	5238 (1178)
<b>F<sub>a</sub> Axial force max. @ survival wind speed</b>	N (lb)	10577 (2378)
<b>M Torque maximum @ survival wind speed Nm (ft lb)</b>	Nm (lb ft)	4883 (3602)

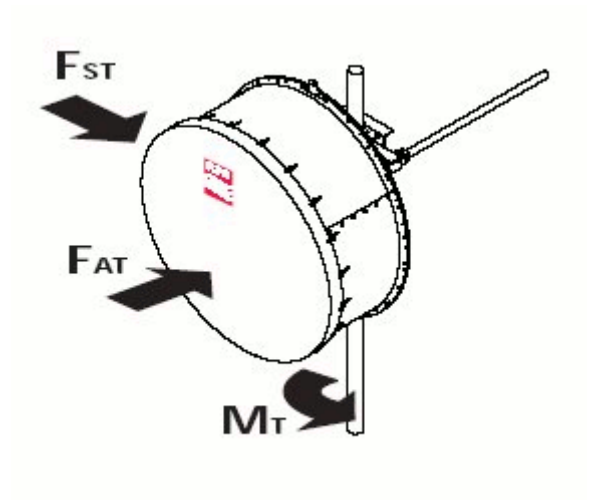

Package dimensions valid for delivery from European factory. Deliveries from other factories might differ.

**External Document Links**

- [Antenna Installation](#)
- [RF interface installation](#)
- [RPE \(IQ-Link format\)](#)
- [RPE \(PDF format\)](#)
- [RPE \(Pathloss format\)](#)

**Notes**