



These antennas feature a very broad frequency band and rugged construction. Radiating elements are constructed of copper alloy, encased in a weather resistant low loss fiberglass radome. The BA6110 ""Heavy Duty"" is permanently affixed to a unique mounting fixture which allows mounting on top of or along-side of most vertical supports. Due to their wide bandwidth, they are ideal for use as emergency backup antennas. Their size and mounting fixtures allow for easy storage and fast installation.

**FEATURES / BENEFITS**

- Broadband - reduces backup inventory and the need for multiple antennas.
- Fiberglass radome protects radiating elements in hostile environments.
- Copper elements maximize system performance while minimizing the possibility of intermod.



BA6110 Series

**Technical features**

**ELECTRICAL SPECIFICATIONS**

<b>Horizontal Pattern</b>		OmniDirectional
<b>Frequency Range</b>	MHz	380 - 440
<b>Horizontal Beamwidth</b>	deg	N/A
<b>Gain</b>	dBi (dBd)	2.1
<b>Vertical Beamwidth</b>	deg	78
<b>Polarization</b>		Vertical
<b>VSWR</b>		< 1.5:1
<b>Bandwidth for 1.5:1 VSWR</b>	MHz	< 1.5:1
<b>Impedance</b>	Ohms	50
<b>Maximum Power Input</b>	W	500
<b>Lightning Protection</b>		Direct Ground

**GENERAL SPECIFICATIONS**

<b>Antenna Type</b>		Fiberglass Omni
---------------------	--	-----------------



**MECHANICAL SPECIFICATIONS**

Connector Type		N Female
Connector Location		Bottom
Weight	kg (lb)	3 (7)
Mount Type		Fixed
Mounting Hardware		Stainless Steel U-Bolts (E380-03F)
Rated Wind Speed	km/h (mph)	200 (125)
Flexible Extensions		None
Overall Length	m (ft)	1.01 (3.3)
Element Housing Length	m (ft)	0.82 (2.7)
Mounting Pipe Diameter	m (in)	0.08 (3)
Support Pipe Length	m (ft)	0.32 (1.04)
Radiating Element Material		Brass
Element Housing Material		Fiberglass
Radome Color		White RAL9010
Mounting Hardware Material		Stainless Steel U-Bolts (E380-03F)
Support Pipe Material		Black Anodized Aluminum
Max Wind Loading Area	m <sup>2</sup> (ft <sup>2</sup> )	0.07 (0.75)
Bend Mom @ Rated Wind 1" Below Top of Mt Pipe	N m (ft lbf)	42 (31.2)
Wind Load - Side @ Rated Wind	N (lbf)	209 (47)

**PACKAGING INFORMATION**

Shipping Weight	kg (lb)	5 (11)
Shipping Comment		Packed w/antenna

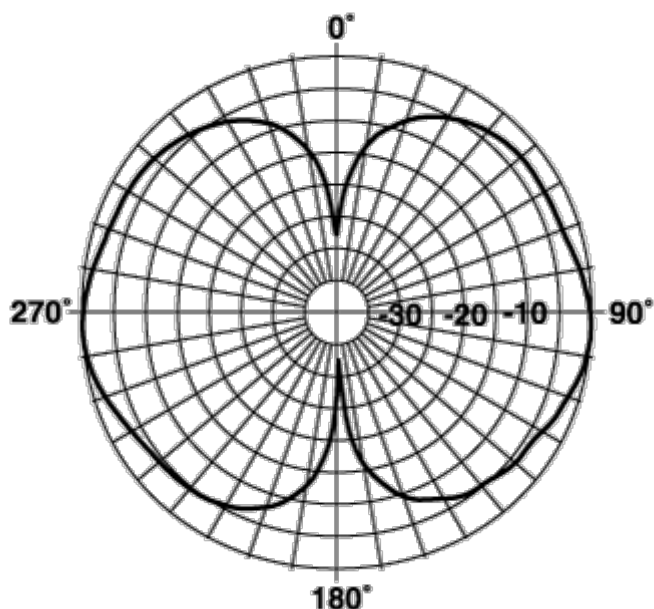

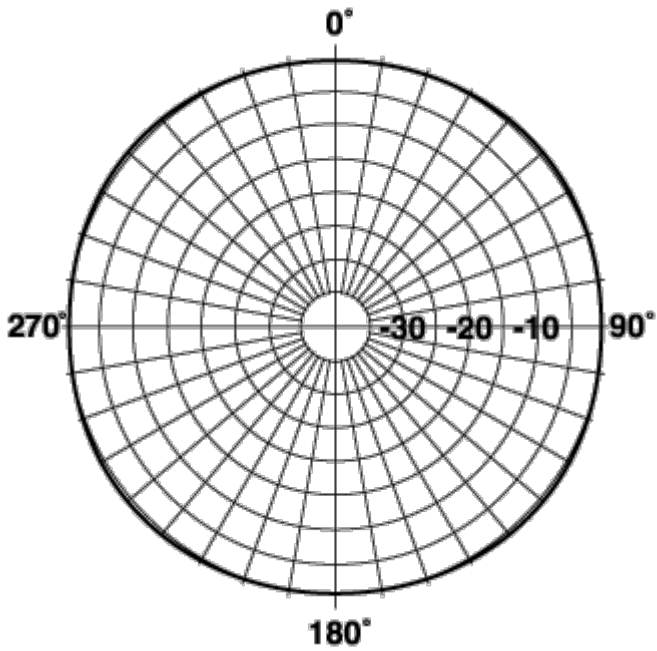

External Document Links

Notes

- Radiating patterns: [Request pattern files](#)