



RFS TrunkLine Antennas are designed for microwave backbone networks, long distance, high capacity links

A choice between tested and validated ultra-high (ETSI EN 302 217 Class 3 and FCC Class A)

electrical performance or high (ETSI Class 2 and FCC Class B) performance

Sizes ranging from 1.8 m (6 ft) to 4.6 m (15 ft)

Single- and dual-polarized models with the ability to upgrade from single to dual polarization and change frequencies in the field in most cases

FEATURES / BENEFITS

- Field-proven reliability and long life
- Support for winds up to 200 km/h (125 mph) with high-wind versions that support winds up to 252 km/h (155 mph) and an optional sway bar for added assurance in case mistakes are made during installation
- A single-piece configuration and compact packaging to reduce transportation costs
- Frequencies ranging from 4 GHz to 15 GHz with support for two wideband frequency ranges (5.725-6.875 and 7.125-8.5 GHz) to reduce antenna requirements and simplify logistics



Antenna

Technical features

GENERAL SPECIFICATIONS

Product Type		Point to point antennas
Profile		TrunkLine
Performance		High
Polarization		Single
Antenna Input		PDR 100
Reflector		2-parts
Radome		flexible
Antenna color		White RAL 9010
Swaybar		1: (3.0 m x Ø60 mm)

ELECTRICAL SPECIFICATIONS

Frequency	GHz	10.3 - 10.7
3dB beamwidth	degrees	0.7
Low Band Gain	dBi	47.6
Mid Band Gain	dBi	47.8
High Band Gain	dBi	47.9
F/B Ratio	dB	70
XPD	dB	30
Max VSWR / R L	VSWR / dB	1.08 (28.3)
Regulatory Compliance		ETSI EN 302217 Range 1, class 2 FCC Category A



MECHANICAL SPECIFICATIONS

Diameter	ft (m)	10 (3)
Elevation Adjustment	degrees	± 5
Azimuth Adjustment	degrees	± 5
Polarization Adjustment	degrees	± 5
Mounting Pipe Diameter minimum	mm (in)	114 (4.5)
Mounting Pipe Diameter maximum	mm (in)	114 (4.5)
Approximate Weight	kg (lb)	290 (638)
Survival Windspeed	km/h (mph)	200 (125)
Operational Windspeed	km/h (mph)	190 (118)

STRUCTURE

Radome Material	PVC coated fabric
-----------------	-------------------

FURTHER ACCESSORIES

optional Swaybar	1: SMA-SK-60-3000A (3.0 m x Ø60 mm)
Further Accessories	SMA-WK-10 : Wind Kit SMA-SKO-UNIVERSAL-L : Universal sway bar fixation kit

MOUNTOUTLINE

Dimension_A	mm (in)	3220 (126.8)
Dimension_B	mm (in)	1640 (64.6)
Dimension_C	mm (in)	550 (21.7)
Dim_D- 114mm(4.5_in)Pipe	mm (in)	190 (7.5)
Dimension_E	mm (in)	370 (14.6)
Dimension_F	mm (in)	1440 (56.9)

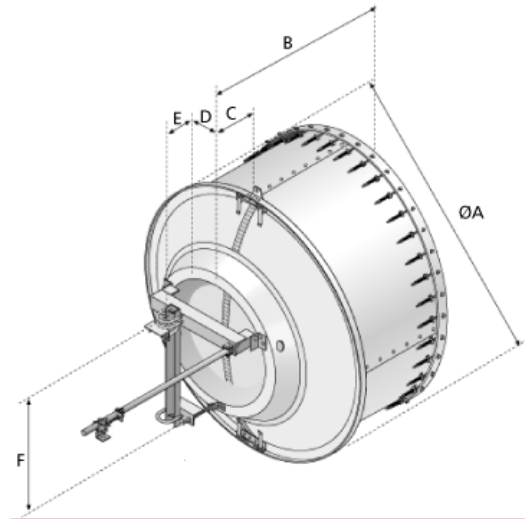



WINDLOAD

F_s Side force max. @ survival wind speed	N (lb)	9590 (2148)
M Torque maximum @ survival wind speed Nm (ft lb)	Nm (lb ft)	10240 (7600)
F_a Axial force max. @ survival wind speed	N (lb)	19370 (4340)



External Document Links

- [Complete Antenna installation](#)
- [RPE \(IQ-Link format\)](#)
- [RPE \(PDF format\)](#)
- [RPE \(Pathloss format\)](#)

Notes