



Designed for: Marine environments, off-shore locations, industrial and highly corrosive locations, volcanic areas, tropical climates mountaintops with severe wind, ice and snow conditions.
Available in frequencies ranging from 3.6 to 26.5 GHz and sizes 0.6m (2ft) to 3.7m (12ft) as single or dual polarized models.

FEATURES / BENEFITS

- Reflectors and shrouds painted in- and outside with 2-component epoxy paint
- Feeds painted with a 2-component epoxy paint
- Mounting hardware and attachment hardware in corrosion-resistant ISO 3506 A4 (SAE 316L) steel stabilized with molybdenum
- Steel mounting with a extended galvanic layer
- Screws, connectors apply additional silicon sealant during installation
- A wind kit supports winds up to 252 km/h (155 mph)
- Wind kits are factory installed for 1.8m (6 ft) and larger antennas
- A single-piece reflector ensures best protection to antenna surfaces
- A flexible radome that is designed to avoid snow accumulation for antennas 1.2 m (4 ft) and larger



Antenna

Technical features

GENERAL SPECIFICATIONS

Product Type		Point to point antennas
Profile		HarshAreasLine
Performance		High
Polarization		Single
Antenna Input		CPR137G
Reflector		1-part
Radome		flexible
Antenna color		White RAL 9010
Swaybar		1: (3.0 m x Ø60 mm)

ELECTRICAL SPECIFICATIONS

Frequency	GHz	5.925 - 6.425
3dB beamwidth	degrees	0.9
Low Band Gain	dBi	44.8
Mid Band Gain	dBi	45.1
High Band Gain	dBi	45.4
F/B Ratio	dB	70
XPD	dB	30
Max VSWR / R L	VSWR / dB	1.06 (30.7)
Regulatory Compliance		ETSI EN 302217 Range 1, class 2 FCC Category A



MECHANICAL SPECIFICATIONS

Diameter	ft (m)	12 (3.7)
Elevation Adjustment	degrees	± 5
Azimuth Adjustment	degrees	± 5
Polarization Adjustment	degrees	± 5
Mounting Pipe Diameter minimum	mm (in)	114 (4.5)
Mounting Pipe Diameter maximum	mm (in)	114 (4.5)
Approximate Weight	kg (lb)	420 (924)
Survival Windspeed	km/h (mph)	252 (155)
Operational Windspeed	km/h (mph)	190 (118)

STRUCTURE

Radome Material	PVC coated fabric
-----------------	-------------------

FURTHER ACCESSORIES

optional Swaybar	1: SMA-SK-60-3000A (3.0 m x Ø60 mm)
Further Accessories	SMA-SKO-UNIVERSAL-L : Universal sway bar fixation kit

MOUNT OUTLINE

Dimension_A	mm (in)	3800 (150)
Dimension_B	mm (in)	1880 ()
Dimension_C	mm (in)	670 (26.5)
Dim_D-114mm(4.5_in)Pipe	mm (in)	190 (7.5)
Dimension_E	mm (in)	370 (14.57)
Dimension_F	mm (in)	1580 (62.5)

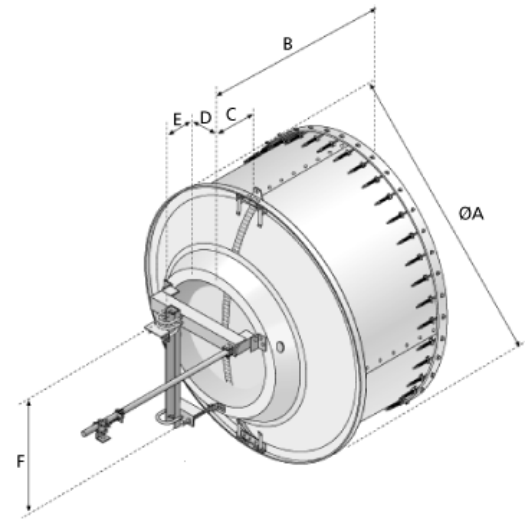



WINDLOAD

Fa Axial force max. @ survival wind speed	N (lb)	43234 (9688)
M Torque maximum @ survival wind speed Nm (ft lb)	Nm (lb ft)	26016 (19375)
Fs Side force max. @ survival wind speed	N (lb)	21422 (4798)



External Document Links

- [Complete Antenna installation](#)
- [RPE \(IQ-Link format\)](#)
- [RPE \(PDF format\)](#)
- [RPE \(Pathloss format\)](#)

Notes