



Designed for: Marine environments, off-shore locations, industrial and highly corrosive locations, volcanic areas, tropical climates mountaintops with severe wind, ice and snow conditions.  
Available in frequencies ranging from 3.6 to 26.5 GHz and sizes 0.6m (2ft) to 3.7m (12ft) as single or dual polarized models.

**FEATURES / BENEFITS**

- Reflectors and shrouds painted in- and outside with 2-component epoxy paint
- Feeds painted with a 2-component epoxy paint
- Mounting hardware and attachment hardware in corrosion-resistant ISO 3506 A4 (SAE 316L) steel stabilized with molybdenum
- Steel mounting with a extended galvanic layer
- Screws, connectors apply additional silicon sealant during installation
- A wind kit supports winds up to 252 km/h ( 155 mph)
- Wind kits are factory installed for 1.8m (6 ft) and larger antennas
- A single-piece reflector ensures best protection to antenna surfaces
- A flexible radome that is designed to avoid snow accumulation for antennas 1.2 m (4 ft) and larger



Antenna

**Technical features**

**GENERAL SPECIFICATIONS**

<b>Product Type</b>		Point to point antennas
<b>Profile</b>		HarshAreasLine
<b>Performance</b>		High
<b>Polarization</b>		Single
<b>Antenna Input</b>		PBR 120
<b>Reflector</b>		1-part
<b>Radome</b>		flexible
<b>Antenna color</b>		White RAL 9010
<b>Swaybar</b>		1: (3.0 m x Ø60 mm)

**ELECTRICAL SPECIFICATIONS**

<b>Frequency</b>	GHz	12.7 - 13.25
<b>3dB beamwidth</b>	degrees	0.7
<b>Low Band Gain</b>	dBi	47.6
<b>Mid Band Gain</b>	dBi	47.7
<b>High Band Gain</b>	dBi	47.9
<b>F/B Ratio</b>	dB	71
<b>XPD</b>	dB	30
<b>Max VSWR / R L</b>	VSWR / dB	1.08 (28.3)
<b>Regulatory Compliance</b>		ETSI EN 302217 Range 1, class 2 FCC Category A



**MECHANICAL SPECIFICATIONS**

Diameter	ft (m)	8 (2.4)
Elevation Adjustment	degrees	± 5
Azimuth Adjustment	degrees	± 5
Polarization Adjustment	degrees	± 5
Mounting Pipe Diameter minimum	mm (in)	114 (4.5)
Mounting Pipe Diameter maximum	mm (in)	114 (4.5)
Approximate Weight	kg (lb)	180 (396)
Survival Windspeed	km/h (mph)	252 (155)
Operational Windspeed	km/h (mph)	190 (118)

**STRUCTURE**

Radome Material	PVC coated fabric
-----------------	-------------------

**FURTHER ACCESSORIES**

optional Swaybar	1: SMA-SK-60-3000A (3.0 m x Ø60 mm)
Further Accessories	SMA-SKO-UNIVERSAL-L : Universal sway bar fixation kit

**MOUNT OUTLINE**

Dimension_A	mm (in)	2616 (103.4)
Dimension_B	mm (in)	1450 (57.1)
Dimension_C	mm (in)	460 (18.1)
Dim_D- 114mm(4.5_in)Pipe	mm (in)	190 (7.5)
Dimension_E	mm (in)	310 (12.3)
Dimension_F	mm (in)	1120 (44.1)

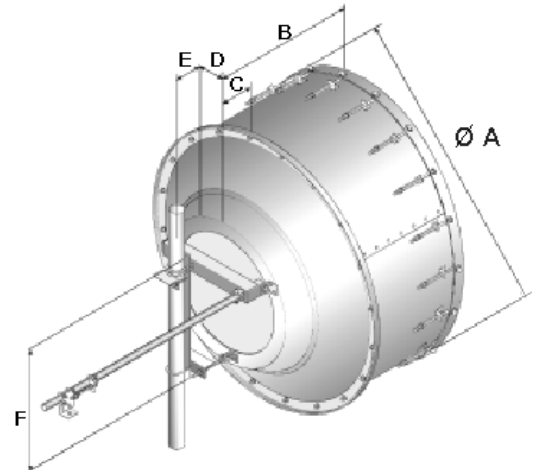



**WINDLOAD**

<b>Fa Axial force max. @ survival wind speed</b>	N (lb)	19344 (4333)
<b>M Torque maximum @ survival wind speed Nm (ft lb)</b>	Nm (lb ft)	9313 (6875)
<b>Fs Side force max. @ survival wind speed</b>	N (lb)	9922 (2222)



**External Document Links**

- [Complete Antenna installation](#)
- [RPE \(IQ-Link format\)](#)
- [RPE \(PDF format\)](#)
- [RPE \(Pathloss format\)](#)

**Notes**