



HB114-U6S12-200-LI

HYBRIFLEX® RRH Hybrid Cable Solution 6x12, 6AWG

Low-Inductance, 1-1/4", Single-Mode Fiber With DLC Connectors

RFS' HYBRIFLEX Remote Radio Head (RRH) hybrid feeder cabling solution combines optical fiber and DC power for RRHs in a single lightweight aluminum corrugated cable, making it the world's most innovative solution for RRH deployments.

This low-inductance version of HYBRIFLEX allows mobile operators deploying an RRH architecture to deploy >400ft sites without the danger of power-cycling their RRHs due to voltage swings, which could occur in some specific instances. It combines bend-insensitive single-mode fiber (12 pairs of DLC connectors), 6 pairs of low-inductance DC wires and 9 pairs of 18AWG wires used to carry alarm signals. The package also includes a special RFS-designed DC insulating boot, used to properly protect and insulate the DC wires after stripping the jacket, avoiding possible short-circuits while wiring it to the distribution boxes. Standard RFS CELLFLEX® accessories can be used with HYBRIFLEX cable.

FEATURES / BENEFITS

- DC Wire Insulator (Patent pending) – Used at the DC wire connection in distribution boxes, prevents potential short circuits
- Aluminum corrugated armor with outstanding bending characteristics – Minimizes installation time and enables mechanical protection and shielding
- Same accessories as 1-1/4" coaxial cable – Saves installation costs and time
- Outer conductor grounding – Eliminates typical grounding requirements and saves on installation costs
- Lightweight solution and compact design – Decreases tower loading
- Robust cabling – Eliminates need for expensive cable trays and ducts
- Optical fiber and power cables housed in single corrugated cable – Saves CAPEX by standardizing RRH cable installation and reducing installation requirements
- Outdoor, flame-retardant jacket – Ensures long-lasting cable protection



HYBRIFLEX Series

Technical features

STRUCTURE

Cable Type		HYBRIFLEX® Low Inductance
Size		1-1/4
Fire Performance		Flame Retardant
Length	m (ft)	60.96 (200)

MECHANICAL SPECIFICATIONS

Outer Diameter Nominal	mm (in)	39 (1.54)
Cable Weight	kg/m (lb/ft)	2.52 (1.7)
Minimum Bending Radius, Single Bend	mm (in)	152 (6)
Minimum Bending Radius, Multi Bends	mm (in)	254 (10)
Recommended / Maximum Clamp Spacing	m (ft)	1 / 1.2 (3.25 / 4)



HB114-U6S12-200-LI

HYBRIFLEX® RRH Hybrid Cable Solution 6x12, 6AWG

Low-Inductance, 1-1/4", Single-Mode Fiber With DLC Connectors

DC POWER CABLE SPECIFICATIONS

Number of DC Pairs		6
Maximum DC-Resistance Power Cable	Ω/km (Ω/kft)	1.4 (0.42)
Cross Section of Power Cable	mm ² (AWG)	13.3 (6)
DC Wire Jacket Material		PVC/Nylon
DC Cable Single Bending Radius	mm (in)	137 (5.4)
DC Cable Diameter	mm (in)	9.3 (0.365)
DC Cable Jacket		PVC/Nylon
DC Standards (Meets or Exceeds)		For use in Type RHC per UL 2882,PVC/Nylon,RoHS/REACH Compliant
Break-out length	mm(in)	812.8 +/-0 (32 +/-0)
DC Cable sealing method		Semi-rigid flame-retarded polyolefin, with hot melt adhesive
Alarm Wire		18 (9 twisted pairs), 0.8mm2 (18AWG)

CABLE JACKET

UV-Protection Individual and External Jacket		Yes
--	--	-----

ARMOR SPECIFICATIONS

Armor Type		Corrugated Aluminum
Maximum DC-Resistance of Armor	Ω/km (Ω/kft)	0.9 (0.27)
Diameter Corrugated Armor	mm (in)	36 (1.42)

F/O CABLE SPECIFICATIONS

F/O Cable Type		Single-Mode, Bend Tolerant
Number of F/O Pairs		12
Core/Clad	μm	9/125
Secondary Protection Nominal	μm (in)	900 (0.035)
Single Bending Radius	mm (in)	137 (5.4)
F/O Standards (Meets or Exceeds)		UL Listed Type OFNR (UL1666), RoHS Compliant
Optical Loss	dB/Km	0.5 @ 1310 nm 0.5 @ 1550 nm
Fiber Termination End 1		DLC Connectors
Fiber Termination End 2		DLC Connectors
FO Break-out length	mm(in)	939.8 +/-50.8 (37 +/-2)
Cable sealing method		Semi-rigid flame-retarded polyolefin, with hot melt adhesive

TESTING AND ENVIRONMENTAL

Storage Temperature	°C (°F)	-40 to 70 (-40 to 158)
Operation Temperature	°C (°F)	-40 to 65 (-40 to 158)
Installation Temperature	°C (°F)	-20 to 65 (-4 to 149)
Jacket Specifications		UL2882 Type RHC, UL listed
Alarm Wire Standards (Meets or Exceeds)		UL Standard 1063, 1581 VW-1, MTW Oil and Gasoline RES1 SUNRES (Cable meets UL requirements), RoHS/REACH Compliant



HB114-U6S12-200-LI

HYBRIFLEX® RRH Hybrid Cable Solution 6x12, 6AWG

Low-Inductance, 1-1/4", Single-Mode Fiber With DLC Connectors

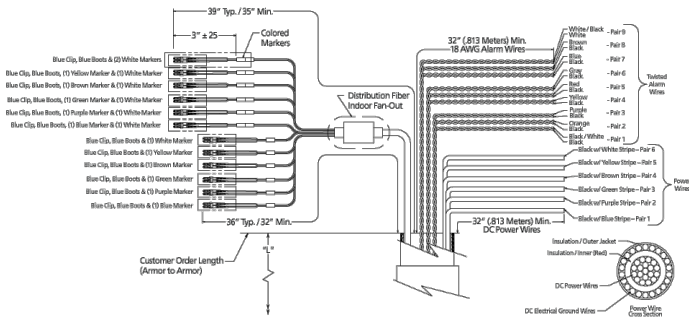

Drawing



DC Wire Insulator

[External Document Links](#)

[Installation Guidelines](#)

[Quick Ship 2.0 Program Information](#)

[View factory test results on-line simply by entering the product serial number](#)

[View factory test results on-line simply by entering the product serial number](#)

[See how RFS' HYBRIFLEX installation tools can simplify and improve field work for you today](#)

[Notes](#)