



PRODUCT DESCRIPTION

RFS' HYBRIFLEX Remote Radio Head (RRH) hybrid feeder cabling solution combines optical fiber and DC power for RRHs, making it the world's most innovative solution for RRH deployments. It was developed to reduce installation complexity and costs at Cellular sites. HYBRIFLEX allows mobile operators deploying an RRH architecture to standardize the RRH installation process. HYBRIFLEX combines optical fiber (multi-mode or single-mode) and power in a single corrugated cable. It may eliminate the need for junction boxes and can connect multiple RRHs with a single feeder. Standard RFS CELLFLEX® accessories can be used with HYBRIFLEX cable. Both pre-connectorized and on-site options are available.



FEATURES / BENEFITS

- Y Splice power wire for junction box connections - 2 pairs power into 1 position in box
- Lightweight solution and compact design - Decreases tower loading
- Robust cabling - Eliminates need for expensive cable trays and ducts
- Optical fiber and power cables housed in single cable - Saves CAPEX by standardizing RRH cable installation and reducing installation requirements
- UL-Listed components, flame-retardant jacket, UV protected assemblies - Allows both indoor and outdoor applications
- **100% Factory tested - Online test results available**

TECHNICAL FEATURES

STRUCTURE

Cable Type		HYBRIFLEX®
Fire Performance		Flame Retardant
Size		5/8
Length	m (ft)	2.7 (9)

MECHANICAL SPECIFICATIONS

Outer Diameter Nominal	mm (in)	21.4 (0.84)
Cable Weight	kg/m (lb/ft)	0.5 (0.34)
Minimum Bending Radius, Single Bend	mm (in)	102 (4)
Minimum Bending Radius, Multiple Bends	mm (in)	254 (10)
Recommended / Maximum Clamp Spacing	m (ft)	1 / 1.2 (3.25 / 4)

CABLE JACKET

UV-Protection Individual and External Jacket		Yes
--	--	-----



DC POWER CABLE SPECIFICATIONS

Number of DC Pairs		2
Maximum DC-Resistance Power Cable	Ω/km (Ω/kft)	2.2 (0.66)
Cross Section of Power Cable	mm ² (AWG)	8.4 (8)
DC Wire Jacket Material		PVC/Nylon
DC Cable Single Bending Radius	mm (in)	83 (3.3)
DC Cable Diameter	mm (in)	5.5 (0.22)
DC Standards (Meets or Exceeds)		For use in Type MC per UL 1569, PVC Nylon, RoHS/REACH Compliant
Break-out length (Top)	mm (in)	508 (20)
Break-out length (Bottom)	mm (in)	508 (20)
DC cable sealing method		Semi-rigid, flame-retardant polyolefin, with hot melt adhesive

F/O CABLE SPECIFICATIONS

Number of F/O Pairs		2
F/O Cable Type		G657-A2 Single Mode, Bend Tolerant
Core/Clad	μm	9/125
Single Bending Radius	mm (in)	83 (3.3)
F/O Standards (Meets or Exceeds)		UL Listed Type OFNR (UL1666), RoHS Compliant
Optical Loss	dB/Km	0.5 @ 1310 nm 0.5 @ 1550 nm
FO Break-out Length (Top)	mm (in)	508 (20)
FO Break-out Length (Bottom)	mm (in)	1047 (58)
Cable Sealing Method		Semi-rigid flame-retardant polyolefin, with hot melt adhesive
Fiber Termination End 1		DLC Connector
Fiber Termination End 2		DLC Connector with FullAXS Compatibility

TESTING AND ENVIRONMENTAL

Storage Temperature	°C (°F)	-40 to 70 (-40 to 158)
Operation Temperature	°C (°F)	-40 to 65 (-40 to 149)
Installation Temperature	°C (°F)	-20 to 65 (-4 to 149)
Jacket Specifications		UL1569 Type MC, UL Listed

EXTERNAL DOCUMENT LINKS

Installation Guidelines: [Download](#)
 QuickShip 2.0 Program Information: [Download](#)
 On-line Factory Test Results: [View](#)

NOTES

Y-Cable DC Splice on Bottom Breakout, 2 pair DC into 1 pair, for single position DC connection in tower top junction box.



HBF058-08U2S2-09FY

HYBRIFLEX® RRH Hybrid Jumper, 5/8", 2 pair 8AWG, 2 pair Single-Mode Fiber with DLC to DLC/FullAXS Compatible Connectors, 9 ft

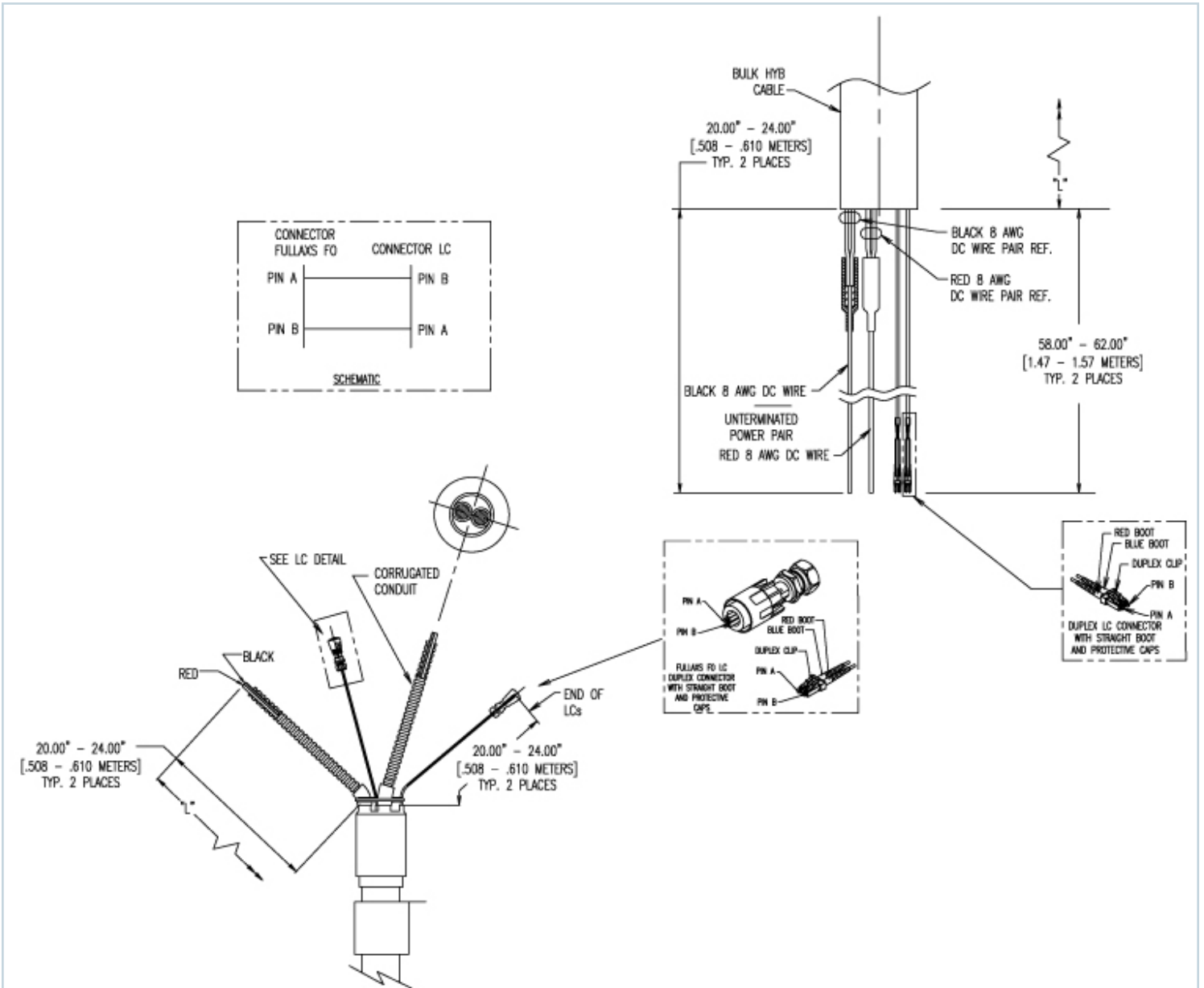

ADDITIONAL ASSEMBLIES - 1 PAIR SM FIBER

Length, ft	Model Number
8	HBF058-08U2S1-08FY
9	HBF058-08U2S1-09FY
10	HBF058-08U2S1-10FY
12	HBF058-08U2S1-12FY
15	HBF058-08U2S1-15FY
20	HBF058-08U2S1-20FY
30	HBF058-08U2S1-30FY
40	HBF058-08U2S1-40FY
60	HBF058-08U2S1-60FY
80	HBF058-08U2S1-80FY
150	HBF058-08U2S1-150FY

ADDITIONAL ASSEMBLIES - 2 PAIR SM FIBER

Length, ft	Model Number
8	HBF058-08U2S2-08FY
9	HBF058-08U2S2-09FY
12	HBF058-08U2S2-12FY
15	HBF058-08U2S2-15FY
20	HBF058-08U2S2-20FY
30	HBF058-08U2S2-30FY
40	HBF058-08U2S2-40FY
70	HBF058-08U2S2-70FY



HBF058-08U2S2-09FY

HYBRIFLEX® RRH Hybrid Jumper, 5/8", 2 pair 8AWG, 2 pair Single-Mode Fiber with DLC to DLC/FullAXS Compatible Connectors, 9 ft

ADDITIONAL ASSEMBLIES - 1 STRAND SM FIBER

Length, ft	Model Number
8	HBF058-08U2SS-08FY
12	HBF058-08U2SS-12FY
15	HBF058-08U2SS-15FY
20	HBF058-08U2SS-20FY
30	HBF058-08U2SS-30FY

ADDITIONAL ASSEMBLIES - 2 STRAND SM FIBER

Length, ft	Model Number
10	HBF058-08U2SS2-10FY
20	HBF058-08U2SS2-20FY
30	HBF058-08U2SS2-30FY
40	HBF058-08U2SS2-40FY
50	HBF058-08U2SS2-50FY
60	HBF058-08U2SS2-60FY
70	HBF058-08U2SS2-70FY
80	HBF058-08U2SS2-80FY
90	HBF058-08U2SS2-90FY
100	HBF058-08U2SS2100FY