



RFS Class 4 antennas are designed to provide the market's best RF performance and allow mobile operators to deploy new microwave links even in ultra-dense areas where high levels of interference are present.

- Available from 15 to 42 GHz frequency in both single (SL) and dual polarization (SLX) versions
- Support for winds up to 250 km/h (155 mph) and even 320 km/h (195 mph) for 0.3m antennas diameter
- An optional sway bar for antennas 1 m (3ft) and larger is available

FEATURES / BENEFITS

- Increase link capacity of the network
 - Improved radiation patterns for ETSI Class 4 providing better performance
 - Less interference and higher carrier-to-interference ratio
 - Allows radios to operate at higher modulation levels
- Minimize the total cost of ownership
 - Improved network efficiency
 - Facilitates better re-use of a frequency channel
 - Small antennas with better link throughput reduces tower leasing fees
- Easy to install
 - Very low weight
 - Compact mounting system
 - Lower cost of installation
- In-field upgrades – flexible feed design
 - Upgrade from single to dual polarization in the field
 - Build for the future – upgrade to the next generation radio in the field



SLX2 SerenityLine

Technical features

GENERAL SPECIFICATIONS

Product Type		Point to point antennas
Profile		SerenityLine
Performance		Super High
Polarization		Dual
Antenna Input		PBR 320
Reflector		1-part
Radome		rigid
Antenna color		White RAL 9010
Swaybar		0: (not applicable)

ELECTRICAL SPECIFICATION

Frequency	GHz	27.5 - 29.5
3dB beamwidth	degrees	1.2
Low Band Gain	dBi	42.2
Mid Band Gain	dBi	42.6
High Band Gain	dBi	42.8
F/B Ratio	dB	73
XPD	dB	30
IPI	dB	35
Max VSWR / R L	VSWR / dB	1.29 (18)
Regulatory Compliance		ETSI EN 302217 R4Cl4, Brazil Anatel Class 3



MECHANICAL SPECIFICATIONS

Diameter	ft (m)	2 (0.6)
Elevation Adjustment	degrees	± 20
Azimuth Adjustment	degrees	± 15
Polarization Adjustment	degrees	Dual
Mounting Pipe Diameter minimum	mm (in)	48 (1.9)
Mounting Pipe Diameter maximum	mm (in)	114 (4.5)
Survival Windspeed	km/h (mph)	252 (155)
Operational Windspeed	km/h (mph)	180 (112)
Approximate Weight	kg (lb)	10 (22)

STRUCTURE

Radome Material		rigid
-----------------	--	-------

OTHER ACCESSORIES

optional Swaybar		0: (not applicable)
------------------	--	---------------------

MOUNT OUTLINE

Dimension_A	mm (in)	654 (25.7)
Dimension_B	mm (in)	441 (17.4)
Dimension_C	mm (in)	173 (6.8)
Dim_D-51mm(2_in)Pipe	mm (in)	260 (10.2)
Dim_D-89mm(3.5_in)Pipe	mm (in)	280 (11)
Dim_D-114mm(4.5_in)Pipe	mm (in)	292 (11.5)
Dimension_E	mm (in)	36 (1.4)
Dimension_F	mm (in)	40 (1.6)

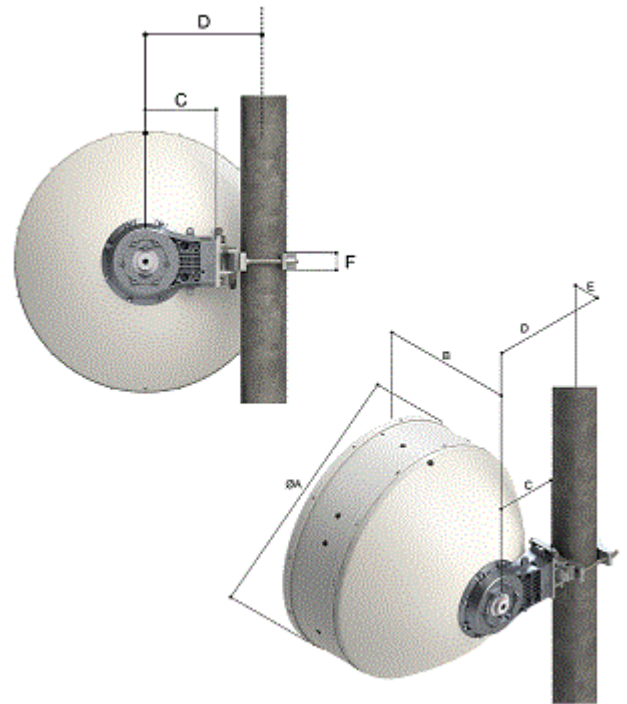

Outline_2ft_SerenityLine



WINDLOAD

Fs Side force max. @ survival wind speed	N (lb)	613 (138)
Fa Axial force max. @ survival wind speed	N (lb)	1238 (278)
M Torque maximum @ survival wind speed Nm (ft lb)	Nm (lb ft)	420 (310)

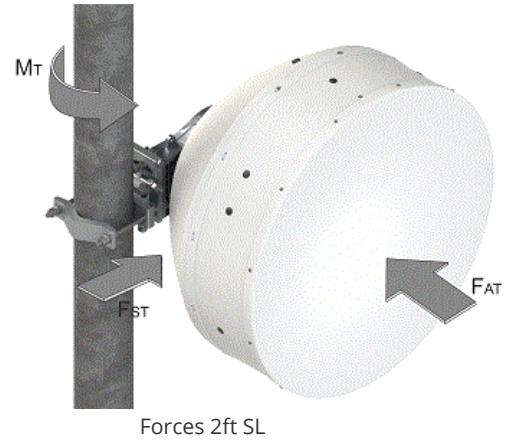

External Document Links

- [Antenna Packing](#)
- [RF interface installation](#)
- [1FT +2FT SC/SCX // SL/SLX MOUNT](#)
- [RPE \(IQ-Link format\)](#)
- [RPE \(pdf format\)](#)
- [RPE \(Pathloss format\)](#)

Notes