

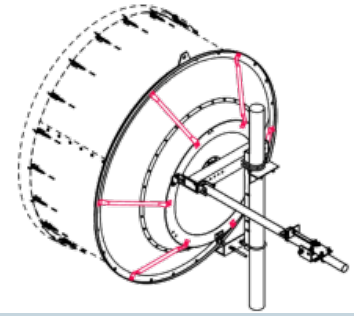

The use of the high wind kit improves the windload performance. The survival windspeed increases to 250 km/h (156 mph).

FEATURES / BENEFITS



Technical features

MECHANICAL PROPERTIES

Diameter	m (ft)	()
Weight	kg (lb)	11.3 (24.9)

STRUCTURE

Product Type		Reinforcement Hardware
Kit Type		Increased Windload
Material		Hot-dip galvanised steel

External Document Links

[Wind kit installation](#)

Notes

The windkit includes only the red marked parts and fixing hardware