

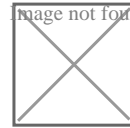

RFS TPS* series of Tappers unevenly split high power cellular signals in fixed ratios from 30:1 to 2:1 with minimal reflections or loss over the wireless bands in the range 350 - 2700 MHz. The innovative asymmetric design ensures an excellent input VSWR and coupling flatness across the band. The lightweight design allows easy attachment to a wall. Designed with only a few solder joints and an air dielectric, loss is minimized and reliability enhanced.

Image not found or type unknown



FEATURES / BENEFITS

- **Splits in ratio 20:1**
- **Small size and weight**
- **200 Watt average power rating**
- **Minimal RF insertion loss**
- **High reliability**
- **N-female connectors**
- **Low PIM**

Technical features

STRUCTURE

Product Type		Unequal Divider/Tapper
Techn. Application		Indoor
Number of Input Ports		1
Number of Output Ports		2

ELECTRICAL SPECIFICATIONS

Impedance	Ohm	50
Input Power (Splitter mode) avg.	W	200
Frequency Range	MHz	350 - 960 1710 - 2700
Connector Type		N female
Max. VSWR / Return Loss	VSWR/dB	1.30/17.7 (1.3)
Insertion Loss max.	dB	0.2
Coupling Value	dB	13.2
Coupling Flatness max.	dB	±2.0
Intermodulation (IM3)		150 dBc with 2x20 W tones

TEMPERATURE SPECIFICATIONS

Temperature Range	°C (°F)	-10 to +55 (14 to +131)
-------------------	---------	-------------------------

MECHANICAL SPECIFICATIONS

Height	mm (in)	101 (3.98)
Width	mm (in)	25 (0.98)
Length	mm (in)	25 (0.98)

TESTING AND ENVIRONMENTAL

Environmental Class		IP65
---------------------	--	------

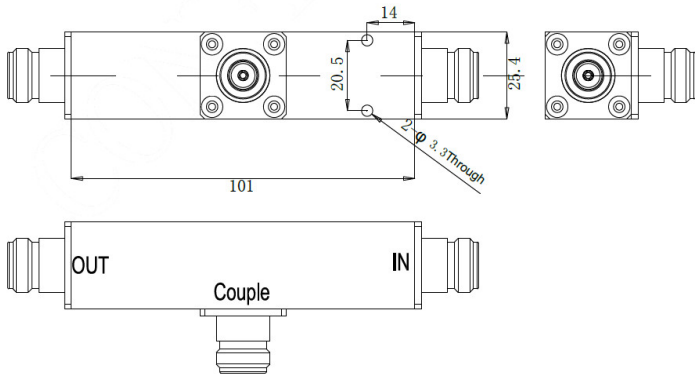

Dimensions in mm

[External Document Links](#)

[Notes](#)