



**UXA6-107BD**

PrimeLine Antenna, Ultra High Performance,  
High Cross Polar Discrimination, Dual Polarized, 6 ft

RFS PrimeLine Antennas are designed for all microwave applications that require best RF performance, especially where interference could be an issue.

A choice between tested and validated ultra-high (ETSI EN 302 217 Class 3 and FCC Class A) electrical performance.

Sizes ranging from 0.6 m (2 ft) to 4.6 m (15 ft)

Dual-polarized models with the ability to change frequencies in the field in most cases

**FEATURES / BENEFITS**

- Extremely high XPD performance for complete isolation between the radions in each polarization
- Excellent radiation pattern envelope (RPE), particularly in cross-polar area
- Support for winds up to 200 km/h (125 mph) with high-wind versions that support winds up to 252 km/h (155 mph) and an optional sway bar for added assurance in case mistakes are made during installation
- A single-piece configuration and compact packaging to reduce transportation costs
- Frequencies ranging from 4 GHz to 23 GHz with support for one ultra wideband frequency range (5.725-7.125 GHz) to reduce antenna requirements and simplify logistics



Antenna

**Technical features**

**GENERAL SPECIFICATIONS**

Product Type		Point to point antennas
Profile		PrimeLine
Performance		Ultra High, High Cross Polar Discrimination
Polarization		Dual
Antenna Input		PDR 100
Reflector		1-part
Radome		flexible
Antenna color		White RAL 9010
Swaybar		1: (2.0 m x Ø60 mm)

**ELECTRICAL SPECIFICATIONS**

Frequency	GHz	10.7 - 11.7
3dB beamwidth	degrees	1
Low Band Gain	dBi	43.5
Mid Band Gain	dBi	43.8
High Band Gain	dBi	44.3
F/B Ratio	dB	73
XPD	dB	40
IPI	dB	45
Max VSWR / R L	VSWR / dB	1.06 (30.7)
Regulatory Compliance		ETSI EN 302217 Range 1, class 3 FCC Category A



**UXA6-107BD**

PrimeLine Antenna, Ultra High Performance,  
High Cross Polar Discrimination, Dual Polarized, 6 ft

**MECHANICAL SPECIFICATIONS**

Diameter	ft (m)	6 (1.8)
Elevation Adjustment	degrees	± 5
Azimuth Adjustment	degrees	± 5
Polarization Adjustment	degrees	± 5
Mounting Pipe Diameter minimum	mm (in)	114 (4.5)
Mounting Pipe Diameter maximum	mm (in)	114 (4.5)
Approximate Weight	kg (lb)	110 (242)
Survival Windspeed	km/h (mph)	200 (125)
Operational Windspeed	km/h (mph)	190 (118)

**STRUCTURE**

Radome Material	PVC coated fabric
-----------------	-------------------

**FURTHER ACCESSORIES**

optional Swaybar	1: SMA-SK-60-2000A (2.0 m x Ø60mm)
Further Accessories	SMA-WK-6A : Wind Kit SMA-SKO-UNIVERSAL-L : Universal sway bar fixation kit

**MOUNTOUTLINE**

Dimension_A	mm (in)	2000 (79)
Dimension_B	mm (in)	1242 (48.9)
Dimension_C	mm (in)	364 (14.3)
Dim_D- 114mm(4.5_in)Pipe	mm (in)	175 (6.9)
Dimension_E	mm (in)	283 (11.1)
Dimension_F	mm (in)	590 (23.2)

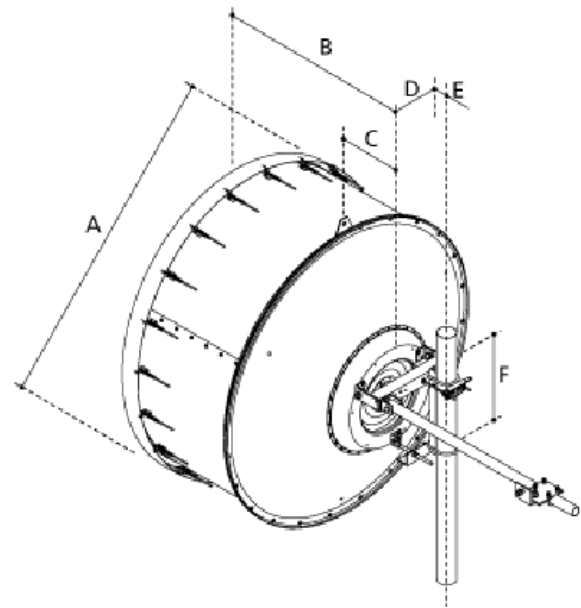



**UXA6-107BD**

PrimeLine Antenna, Ultra High Performance,  
High Cross Polar Discrimination, Dual Polarized, 6 ft

**WINDLOAD**

<b>Fa Axial force max. @ survival wind speed</b>	N (lb)	7500 (1680)
<b>Fs Side force max. @ survival wind speed</b>	N (lb)	3715 (832)
<b>M Torque maximum @ survival wind speed Nm (ft lb)</b>	Nm (lb ft)	2835 (2100)



**External Document Links**

- [Complete Antenna installation](#)
- [RPE \(IQ-Link format\)](#)
- [RPE \(PDF format\)](#)
- [RPE \(Pathloss format\)](#)

**Notes**