



UXA6-190BB2

PrimeLine Antenna, Ultra High Performance,
High Cross Polar Discrimination, Dual Polarized, 6 ft

RFS PrimeLine Antennas are designed for all microwave applications that require best RF performance, especially where interference could be an issue.

A choice between tested and validated ultra-high (ETSI EN 302 217 Class 3 and FCC Class A) electrical performance.

Sizes ranging from 0.6 m (2 ft) to 4.6 m (15 ft)

Dual-polarized models with the ability to change frequencies in the field in most cases

FEATURES / BENEFITS

- Extremely high XPD performance for complete isolation between the radions in each polarization
- Excellent radiation pattern envelope (RPE), particularly in cross-polar area
- Support for winds up to 200 km/h (125 mph) with high-wind versions that support winds up to 252 km/h (155 mph) and an optional sway bar for added assurance in case mistakes are made during installation
- A single-piece configuration and compact packaging to reduce transportation costs
- Frequencies ranging from 4 GHz to 23 GHz with support for one ultra wideband frequency range (5.725-7.125 GHz) to reduce antenna requirements and simplify logistics



Antenna

Technical features

GENERAL SPECIFICATIONS

Product Type		Point to point antennas
Profile		PrimeLine
Performance		Ultra High, High Cross Polar Discrimination
Polarization		Dual
Antenna Input		PBR 220
Reflector		1-part
Radome		flexible
Antenna color		White RAL 9010
Swaybar		1: (2.0 m x Ø60 mm)

ELECTRICAL SPECIFICATIONS

Frequency	GHz	17.7 - 19.7
3dB beamwidth	degrees	0.7
Low Band Gain	dBi	47.5
Mid Band Gain	dBi	48
High Band Gain	dBi	48.4
F/B Ratio	dB	76
XPD	dB	36
IPI	dB	40
Max VSWR / R L	VSWR / dB	1.13 (24.3)
Regulatory Compliance		ETSI EN 302217 Range 1, class 3 FCC Category A



UXA6-190BB2

PrimeLine Antenna, Ultra High Performance,
High Cross Polar Discrimination, Dual Polarized, 6 ft

MECHANICAL SPECIFICATIONS

Diameter	ft (m)	6 (1.8)
Elevation Adjustment	degrees	± 5
Azimuth Adjustment	degrees	± 5
Polarization Adjustment	degrees	± 5
Mounting Pipe Diameter minimum	mm (in)	114 (4.5)
Mounting Pipe Diameter maximum	mm (in)	114 (4.5)
Approximate Weight	kg (lb)	127 (280)
Survival Windspeed	km/h (mph)	252 (155)
Operational Windspeed	km/h (mph)	190 (118)

STRUCTURE

Radome Material	PVC coated fabric
-----------------	-------------------

FURTHER ACCESSORIES

optional Swaybar	1: SMA-SK-60-2000A (2.0 m x Ø60mm)
Further Accessories	SMA-SKO-UNIVERSAL-L : Universal sway bar fixation kit

MOUNTOUTLINE

Dimension_A	mm (in)	2000 (79)
Dimension_B	mm (in)	1242 (48.9)
Dimension_C	mm (in)	364 (14.3)
Dim_D- 114mm(4.5_in)Pipe	mm (in)	175 (6.9)
Dimension_E	mm (in)	283 (11.1)
Dimension_F	mm (in)	590 (23.2)

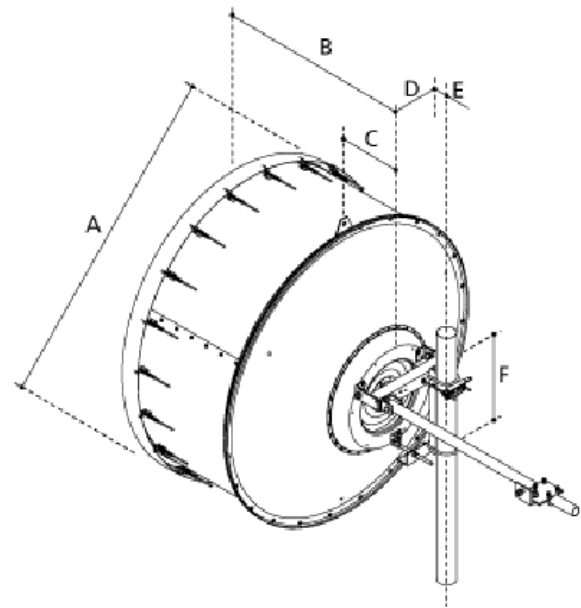



UXA6-190BB2

PrimeLine Antenna, Ultra High Performance,
High Cross Polar Discrimination, Dual Polarized, 6 ft

WINDLOAD

Fa Axial force max. @ survival wind speed	N (lb)	11719 (2625)
Fs Side force max. @ survival wind speed	N (lb)	5805 (1300)
M Torque maximum @ survival wind speed Nm (ft lb)	Nm (lb ft)	4430 (3281)



External Document Links

- [Complete Antenna installation](#)
- [Installation Instructions Microwave Parabolic 6 ft Antennas 250 km/h WindKit](#)
- [RPE \(IQ-Link format\)](#)
- [RPE \(PDF format\)](#)
- [RPE \(Pathloss format\)](#)

Notes